

SIRUBA®

銀爺牌工業用縫紉機

INDUSTRIAL SEWING MACHINE

L819



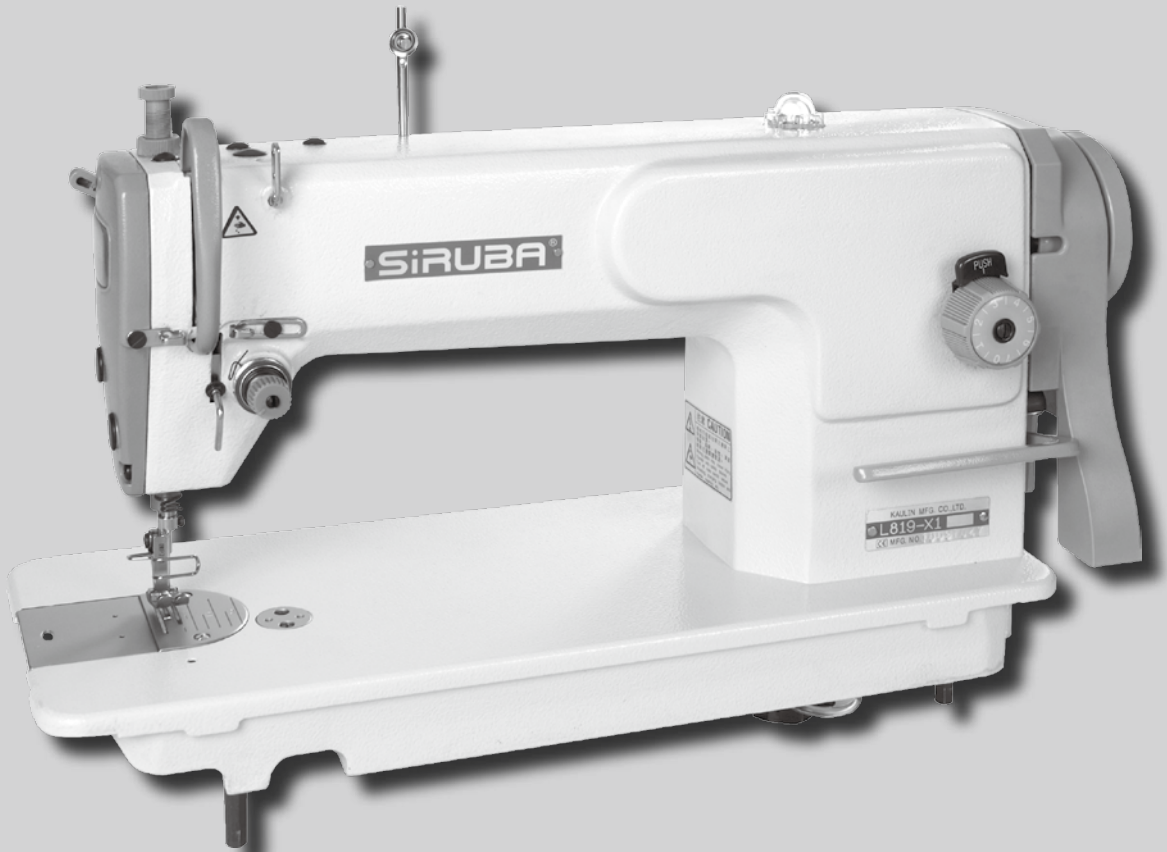



零件圖 PARTS LIST

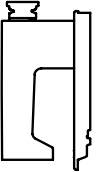

CE

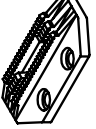
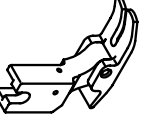





高林股份有限公司
KAULIN MFG. CO., LTD.

								
MODEL	SUB-CLASS	NEEDLE PLATE	FEED DOG	PRESSER FOOT	HOOK ASM	BOBBIN CASE ASM	BOBBIN	NEEDLE
機型	規格	針板	送具	押具	梭頭	梭殼	梭子	針號
L819-X1	厚布料	E702	D702	P711/P712	G112	G201	G301	DB*1#21
L819-X2		E702	D702	P711/P712	G131	G204	G304	DB*1#21

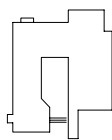
型別件對照表 MODEL COMPARE LIST

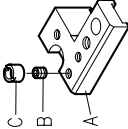
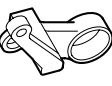
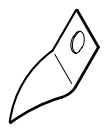
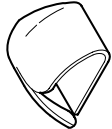
MODEL	SUB-CLASS	BAD	THRAD TAKE UP LEVER COVER	THREAD PLATE	THREAD PLATE	THREAD PLATE	THREAD PLATE	THREAD PLATE	THREAD PLATE	MOVABLE KINFE BRACKET	FIXED KINFE	FIXED KINFE
機 型	規 格	機體下座	天秤蓋	導線片	導線片	導線片	導線片	導線片	導線片	活動刀轉座	固定刀	固定刀
L819 /X1	厚布料	GLA101	GLA11F	GLA34	—	GLA125	—	—	—	—	—	—
L819 /X2		GLA501	GLA511	—	GYA24	—	GYA25	—	—	—	—	—
L819-TRIMMER /X1		GLA101P	GLA11F	GLA34	—	GLA125	—	—	—	LU100D	—	—
L819-TRIMMER /X2		GLA501P	GLA511	—	GYA24	—	GYA25	—	—	LU500	—	LU503

								
MODEL	SUB-CLASS	FIXED KINFE FIXED BRACKET	FIXED KINFE FIXED BRACKET	THREAD TAKE UP LEVER	NEEDLE PLATE	BELT PLATE SPRING	MOVABLE KINFE	
機 型	規 格	固定刀固定座	固定刀固定座	天秤	針線導片	板狀彈簧	活動刀	
L819 /X1	厚布料	—	—	LG113	—	LM08	—	
L819 /X2				LG513		LM26		
L819-TRIMMER /X1		LU118D	—	LG113	LU102	—	LU100D	
L819-TRIMMER /X2		—	A LU118 B SK718 C LU119	LG513	LU502	—	LU500	

型別件對照表 MODEL COMPARE LIST

X1 / X2

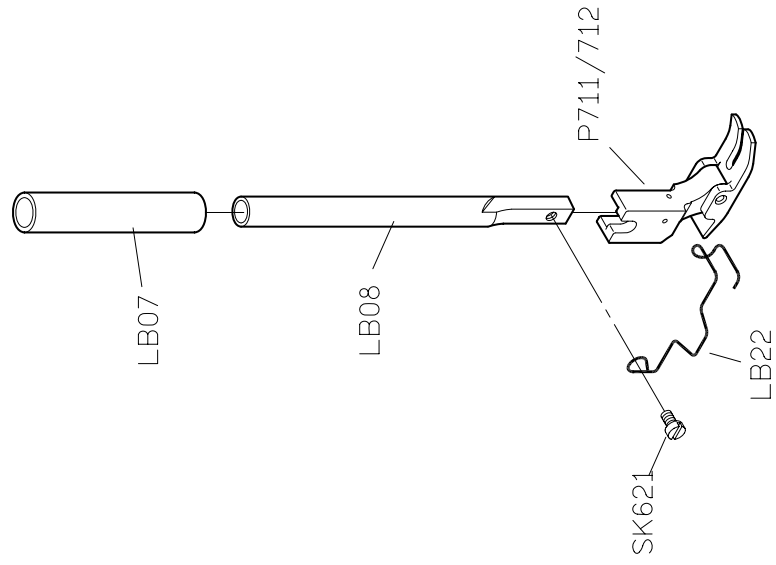

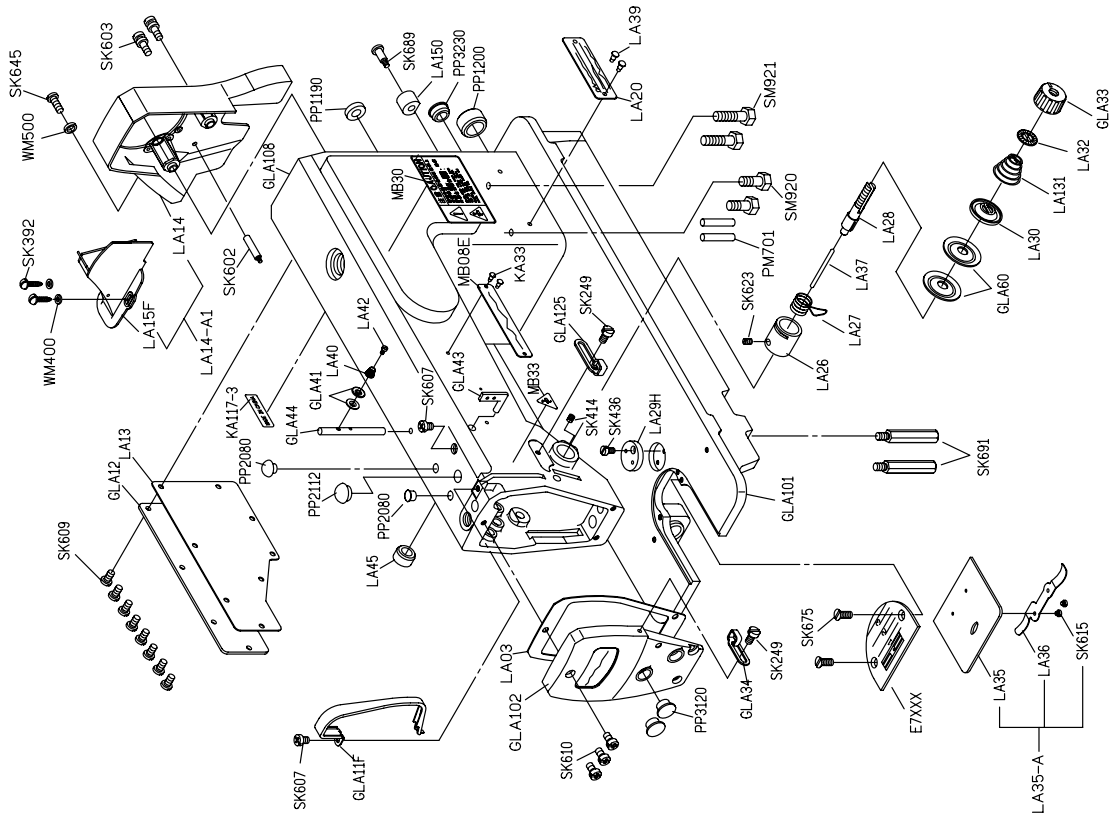

PARTS LIST FOR LA GROUP

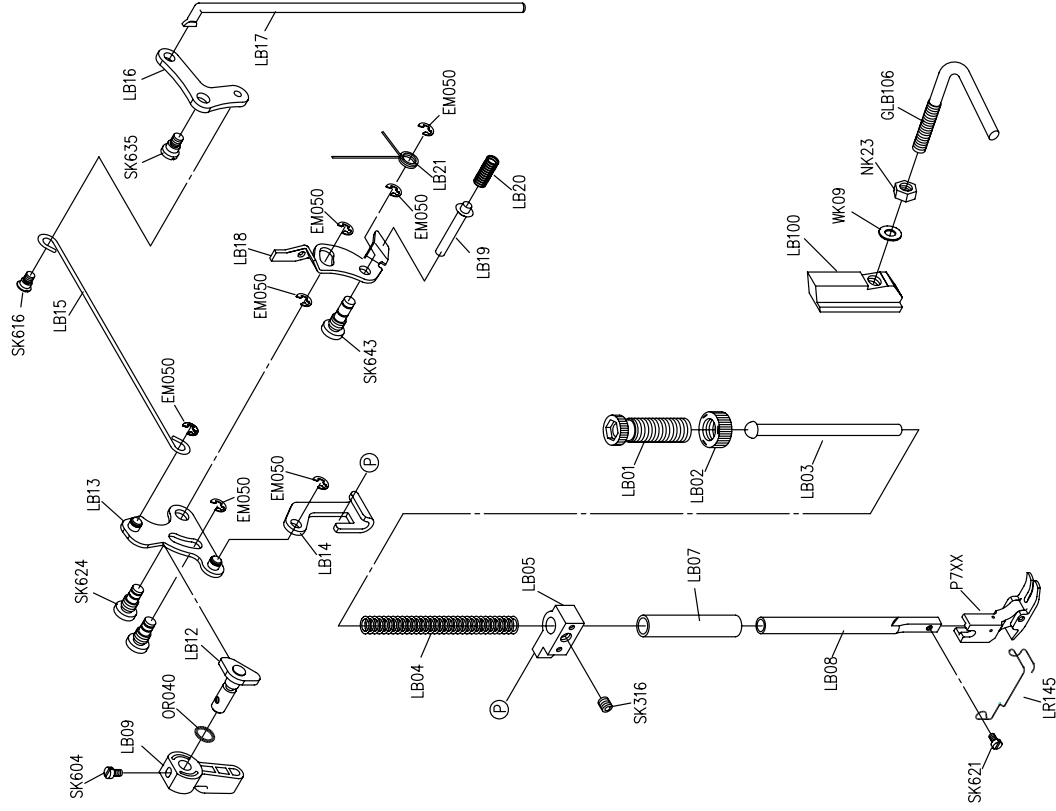

PARTS LIST FOR LB GROUP

PARTS LIST FOR LC GROUP

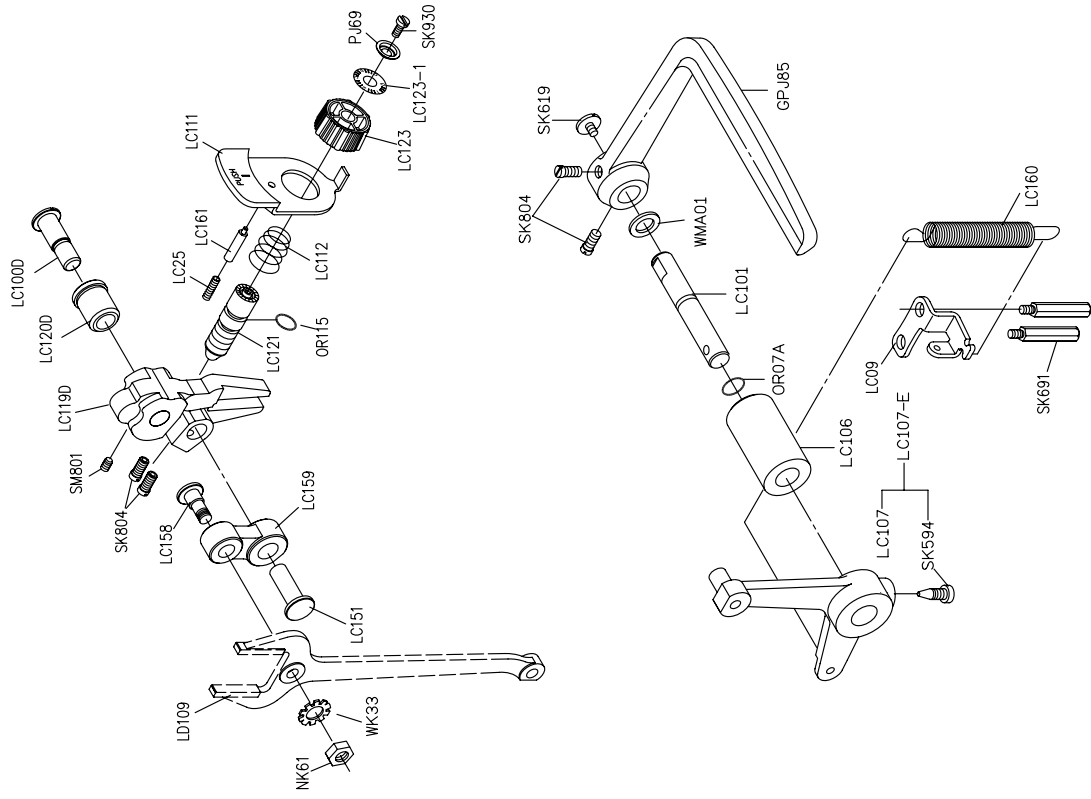

PARTS LIST FOR LD GROUP

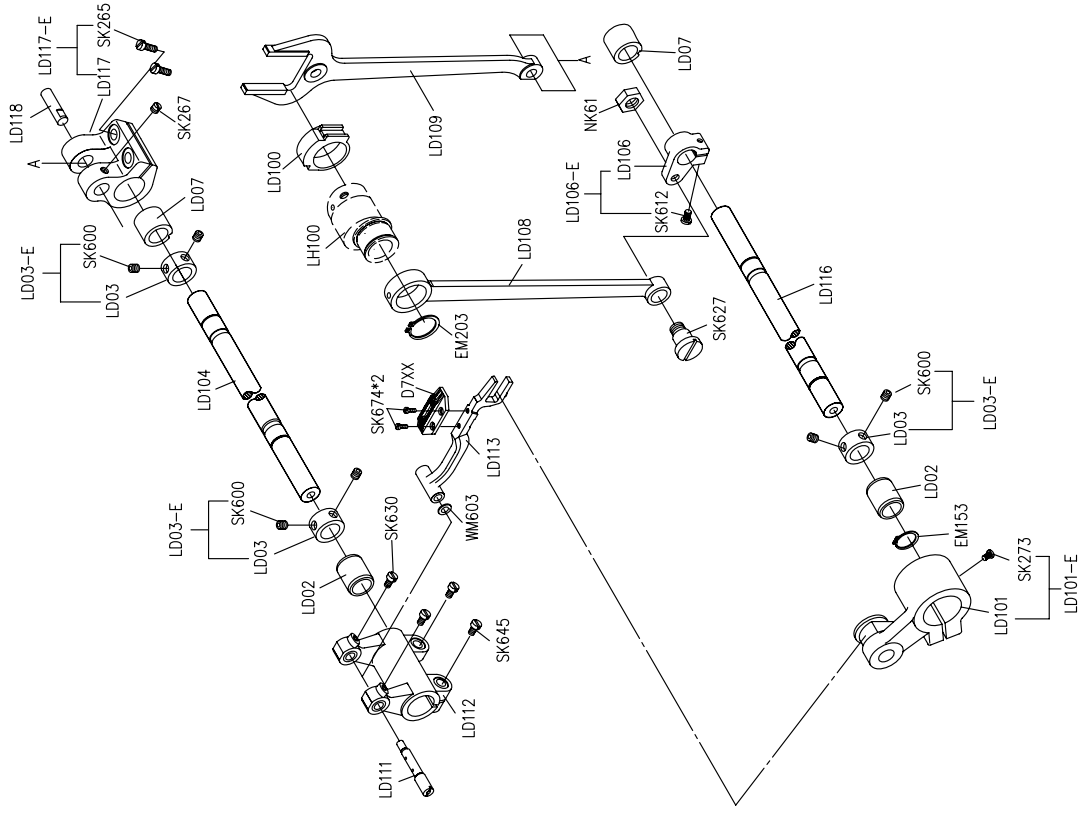

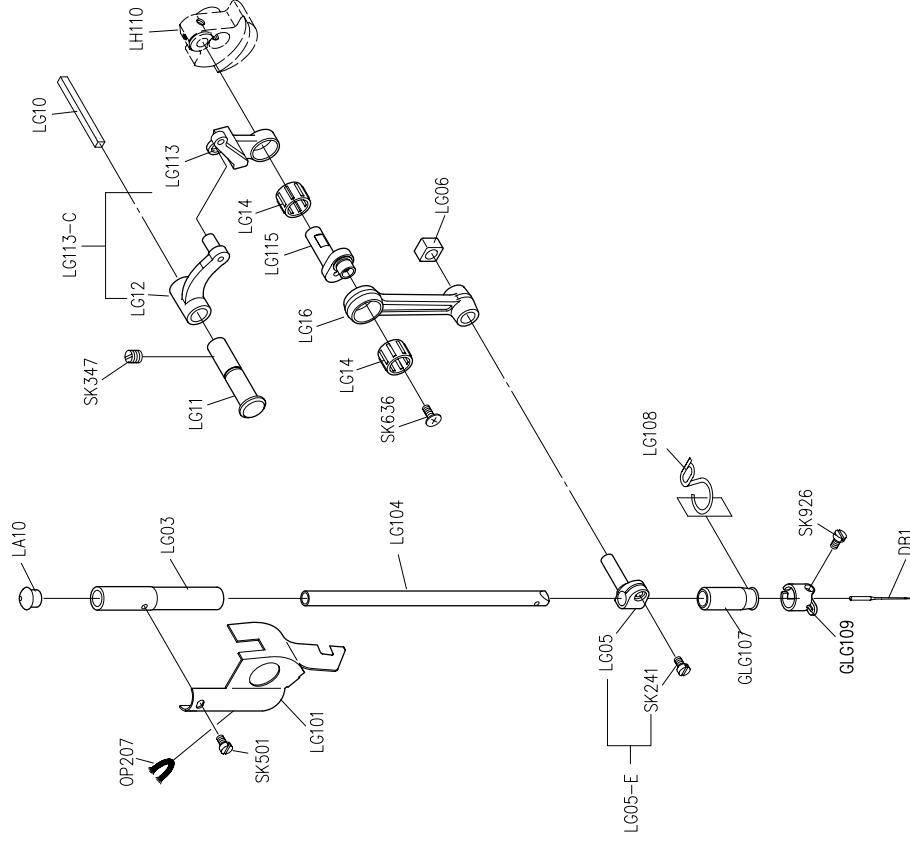
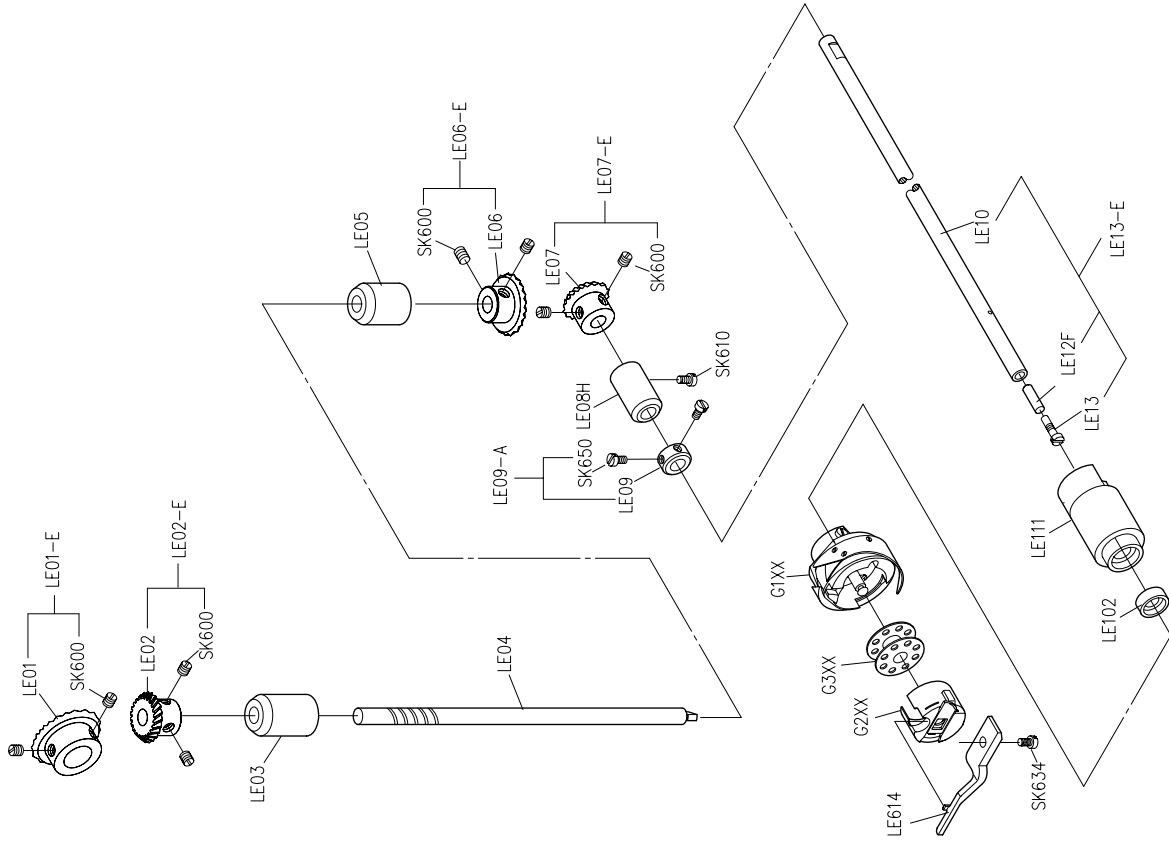

PARTS LIST FOR LE GROUP

PARTS LIST FOR LG GROUP

PARTS LIST FOR LH GROUP

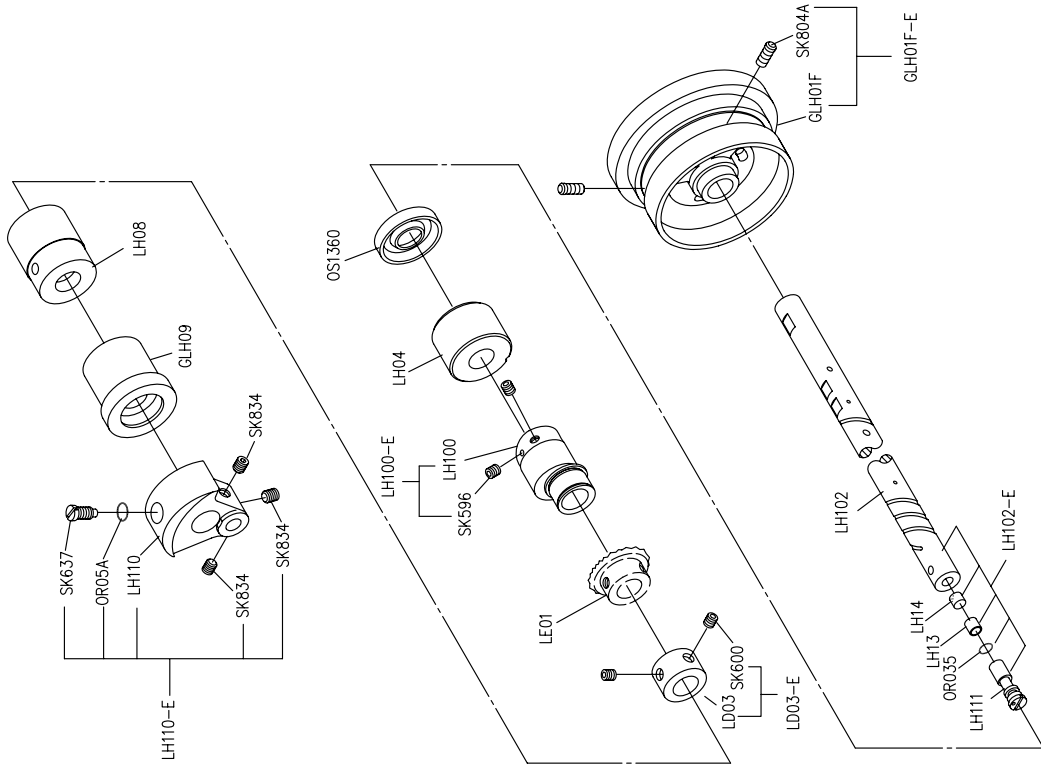

PARTS LIST FOR LL GROUP

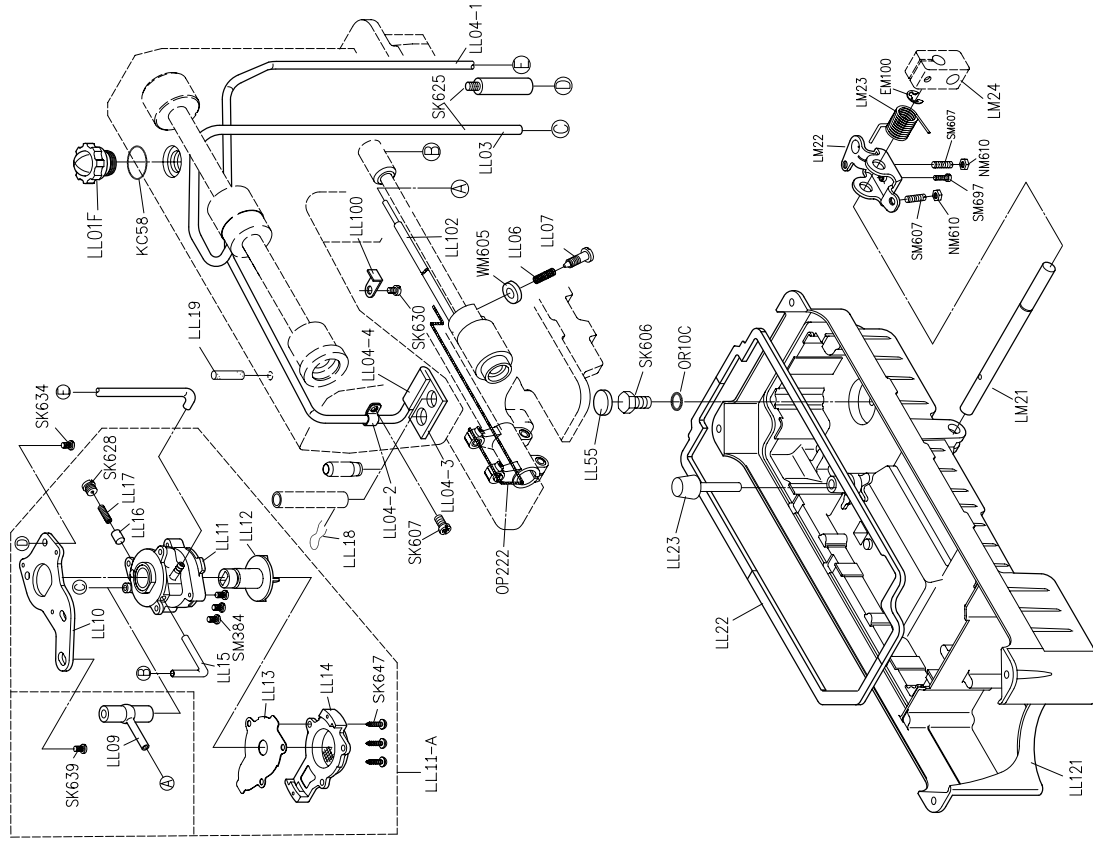



L819

高林股份有限公司 KAULIN MFG. CO., LTD.